

8 - Protections en technopolymère

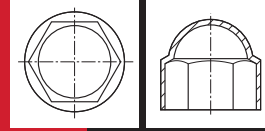

CD



150

TPFL - TPL

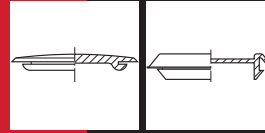

151

TQ

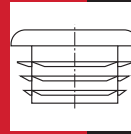

152

TR

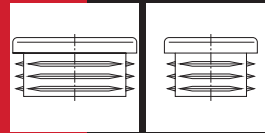

153 & 154

TT

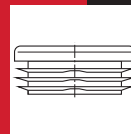

155

TRO

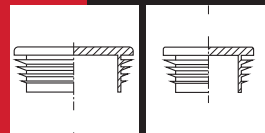

156

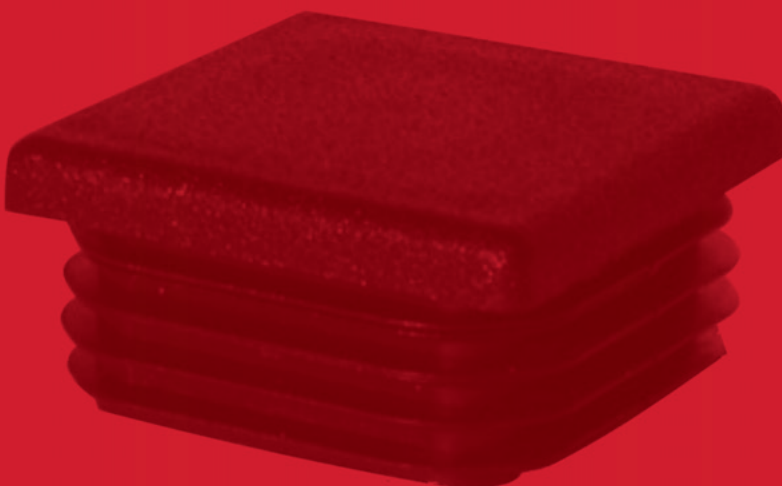

8 - Protections en technopolymère

CD

Bouchon hexagonal

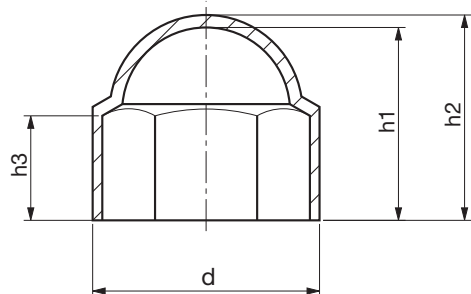
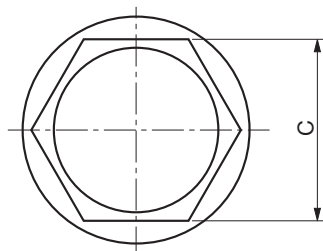

Code	Référence	Filetage métrique	Hexagone	C	d	h1	h2	h3
7371451	CD/7	M 4	7	6,9	9	7,5	8,3	3,5
7371453	CD/8	M 5	8	7,9	10,9	8,5	9,5	5
7371455	CD/10	M 6	10	9,8	12,9	12	13	6
7371457	CD/13	M 8	13	12,8	16,8	14	15	9
7371459	CD/17	M10	17	16,7	21,3	18,5	19,5	9
7371461	CD/19	M12	19	18,7	23,6	20	21,5	11
7371463	CD/22	M14	22	21,7	27,5	22,5	24	12
7371465	CD/24	M16	24	23,7	29,8	25,5	27	14
7371467	CD/27	M18	27	26,8	34	29	43	15
7371469	CD/30	M20	30	29,8	37,7	31	33,2	17
7371471	CD/32	M22	32	31,8	39,7	34	36,2	19
7371473	CD/36	M24	36	35,8	44,4	38	39,2	20
7371475	CD/41	M27	41	40,8	50,1	44	46,5	23
7371477	CD/46	M30	46	45,8	55,9	49	51,5	25
7371479	CD/50	M33	50	49,8	60,5	53	55,5	27
7371481	CD/55	M36	55	54,8	67	57	59,5	30
7371483	CD/60	M39	60	59,7	72	60	62,5	38
7371485	CD/65	M42	65	63,7	76,5	63	65,5	42
7371487	CD/70	M45	70	69,7	85,5	73	75,5	38
7371489	CD/75	M48	75	75	91,6	78,5	81	41
7371491	CD/80	M52	80	80	98	83,4	86,2	43,5
7371493	CD/85	M56	85	85	104,2	88,6	91,6	48
7371495	CD/95	M64	95	95	116,7	102	105,5	55

Matière : Technopolymère noir.

TPFL

Bouchon de protection

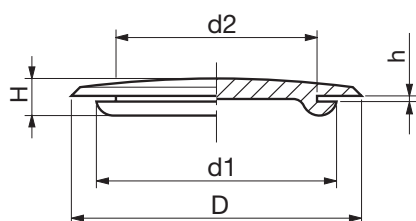

Code	Référence	d2	D	d1	h	H
7372700	TPFL/4,7	4,7	9,3	9,3	1,6	4,6
7372702	TPFL/6,4	6,4	9,5	9,5	1,6	5,0
7372704	TPFL/8	8	14,5	10,6	0,8	4,0
7372706	TPFL/8,0/1	8	14,5	10,6	1,6	4,5
7372708	TPFL/9	9	15	12,4	1,6	6,6
7372710	TPFL/11,2	11,2	17,7	12,8	1,6	6,2
7372712	TPFL/11,5	11,5	17	15,5	1,6	7,0
7372714	TPFL/11,9	11,9	17,5	15,9	1,2	7,1
7372716	TPFL/12	12	19	13,1	0,8	6,5
7372718	TPFL/12,7	12,7	18,7	15,5	1,6	5,6
7372720	TPFL/14,9	14,9	20	18,4	1,3	7,0
7372722	TPFL/15,5	15,5	22	19	1,6	7,5
7372724	TPFL/15,9	15,9	19	19	1,6	7,1
7372726	TPFL/16,3	16,3	20	18,5	1,3	7,0
7372728	TPFL/19	19	25	21,5	1,6	6,5
7372730	TPFL/20	20	25	21,5	1,6	6,5
7372732	TPFL/22	22	28,5	26,6	2,4	8,2
7372734	TPFL/22,5	22,5	28,5	27	1,6	7,5
7372736	TPFL/24,5	24,5	30	27,5	2,4	8,7
7372738	TPFL/25,4	25,4	32	28,3	1,6	9,0
7372740	TPFL/25,4/1	25,4	32	28,3	2,4	9,0
7372742	TPFL/25	25	38,5	28,5	0,8	4,6
7372744	TPFL/32	32	38,2	35,4	3,1	9,0
7372746	TPFL/31,5	31,5	38,2	31,5	0,8	7,0
7372748	TPFL/31,5/1	31,5	38,2	35,4	1,6	7,5
7372750	TPFL/38,2	38,2	43,7	43	1,6	8,2
7372752	TPFL/51,5	51,5	57,5	52,6	1,6	11,4

Matière : PVC noir.

MESURES NON CONTRACTUELLES

TPL

Bouchon de protection

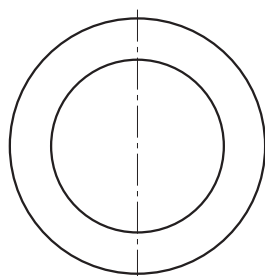
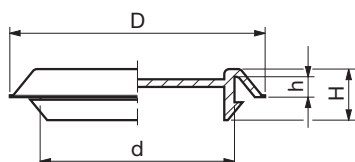

Code	Référence	D	d	h	H
7372600	TPL/9,5	20	9,5	3	8,5
7372602	TPL/12,5	24	12,5	3	9,8
7372604	TPL/14	27	14	3	10,0
7372606	TPL/16	27,5	16	3	9,8
7372608	TPL/19	30,5	19	3	9,8
7372610	TPL/20	31,5	20	3	9,8
7372612	TPL/22	33,5	22	3	9,8
7372614	TPL/25	36	25	1,5	9,0
7372616	TPL/25/1	36,5	25	3	9,8
7372618	TPL/28	39,5	28	3	9,8
7372620	TPL/31,5	41	31,5	3	9,2
7372622	TPL/38	49,5	38	3	9,8
7372624	TPL/47,5	59	47,5	3	9,8
7372626	TPL/50	61,5	50	3	9,8
7372628	TPL/51	62,5	51	3	9,5

Matière : Technopolymere incolore.

MESURES NON CONTRACTUELLES

TQ

Embout à ailettes pour tube carré

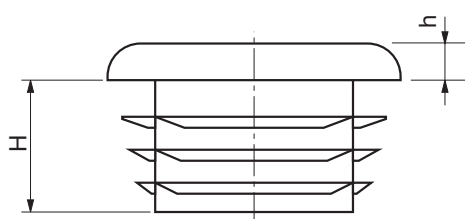
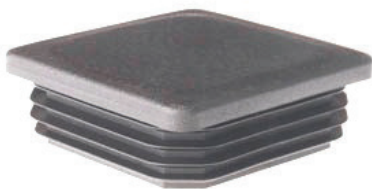

Code	Référence	dimension externe du tube	épaisseur du tube	H	h
7371151	TQ/10x10	10x10	1 - 2	12,0	4
7371153	TQ/12x12	12x12	1 - 2	12,0	4
7371155	TQ/13x13	13x13	0,5 - 2	12,0	4
7371157	TQ/15x15	15x15	1 - 2	14,0	3
7371159	TQ/16x16	16x16	1 - 2,5	11,5	5
7371162	TQ/18x18	18x18	1,5 - 3	11,5	5
7371164	TQ/20x20	20x20	1 - 3	11,5	5
7371166	TQ/22x22	22x22	1 - 3	12,0	5
7371168	TQ/25x25	25x25	1 - 3	11,5	5
7371174	TQ/28x28	28x28	1 - 3	11,5	5
7371176	TQ/30x30	30x30	1 - 3	11,5	5
7371177	TQ/30x30	30x30	2,5 - 4,5	11,5	5
7371182	TQ/35x35	35x35	1 - 3	14,5	5
7371184	TQ/35x35	35x35	2,5 - 5	12,0	5
7371186	TQ/40x40	40x40	1 - 3	14,5	5
7371188	TQ/40x40	40x40	3 - 5	14,5	5
7371189	TQ/40x40	40x40	4,5 - 5,5	14,5	5
7371190	TQ/40x40	40x40	4 - 4,5	14,5	5
7371192	TQ/45x45	45x45	1 - 3	14,5	5
7371194	TQ/50x50	50x50	1 - 2,5	14	5
7371196	TQ/50x50	50x50	2,6 - 4	25,0	6,5
7371200	TQ/50x50	50x50	3,5 - 6	14,5	5
7371214	TQ/55x55	55x55	2 - 4,5	14	5
7371198	TQ/60x60	60x60	1 - 3,5	24,0	5
7371201	TQ/60x60	60x60	3 - 5	17,5	6,5
7371202	TQ/65x65	65x65	1 - 3	21,0	5
7371203	TQ/70x70	70x70	2 - 5	19,0	5
7371204	TQ/70x70	70x70	3,6 - 5	19,5	8
7371212	TQ/80x80	80x80	1,5 - 4	21,0	8
7371206	TQ/80x80	80x80	2,5 - 5	24,0	6
7371207	TQ/90x90	90x90	3 - 5	25,0	6
7371216	TQ/95x95	95x95	3,5 - 5,5	21,5	6
7371210	TQ/100x100	100x100	1 - 4	24,0	7
7371211	TQ/100x100	100x100	5 - 8	24,0	7
7371217	TQ/110x110	110x110	3 - 5	24,0	6
7371213	TQ/120x120	120x120	2,5 - 6	25,0	5
7371218	TQ/140x140	140x140	4 - 7	34,0	6
7371219	TQ/150x150	150x150	5 - 8	27,0	6
7371221	TQ/150x150	150x150	10 - 12,5	27,0	6

Matière : Technopolymère noir.

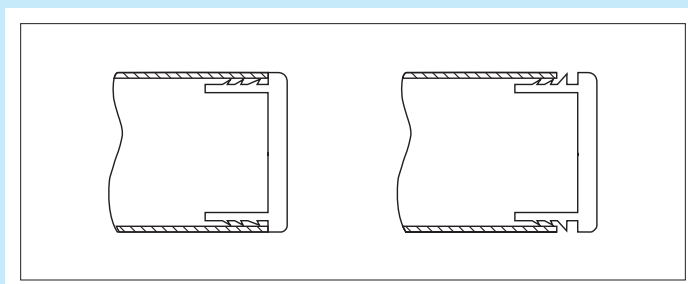

MESURES NON CONTRACTUELLES

TR

Embout à ailettes
pour tube rectangulaire

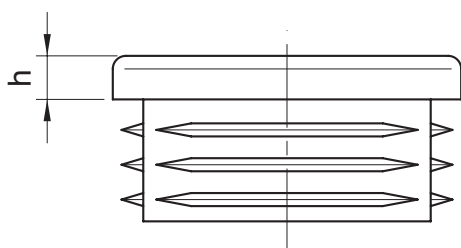

Code	Référence	dimension externe du tube	épaisseur du tube	H	h
7370992	TR/20x10	20x10	1 - 2	11,0	3
7370994	TR/20x15	20x15	1 - 2	11,5	5
7370997	TR/25x10	25x10	1 - 2	11,5	3
7370999	TR/25x15	25x15	1 - 2,5	11,5	5
7371002	TR/25x20	25x20	1 - 3	11,5	5
7371004	TR/30x10	30x10	1 - 2	11,5	5
7371006	TR/30x15	30x15	1 - 3	11,5	5
7371008	TR/30x20	30x20	1 - 3	11,5	5
7371013	TR/30x25	30x25	1 - 3	13,5	3,5
7371015	TR/35x10	35x10	1 - 2	11,5	5
7371026	TR/35x15	35x15	1 - 3	11,5	5
7371016	TR/35x20	35x20	1 - 3	11,5	5
7371018	TR/35x25	35x25	1 - 3	11,5	5
7371020	TR/35x30	35x30	1 - 1,5	15,0	5
7371022	TR/40x10	40x10	1,5 - 2	10,5	5
7371024	TR/40x15	40x15	1 - 2	12,0	5
7371027	TR/40x20	40x20	1 - 3	12,0	5
7371029	TR/40x20	40x20	3	13,0	5
7371030	TR/40x25	40x25	1 - 3	11,5	5
7371032	TR/40x30	40x30	1 - 3	13,0	5
7371036	TR/40x35	40x35	1 - 3	12,0	5
7371037	TR/45x15	45x15	1 - 2	11,0	5
7371039	TR/45x20	45x20	1 - 3	11,5	5
7371041	TR/45x25	45x25	1,5 - 3	12,0	5
7371042	TR/45x30	45x30	1 - 2,5	12,0	5
7371043	TR/45x35	45x35	1 - 3,5	12,0	5
7371044	TR/50x10	50x10	1 - 2	12,0	3,5
7371046	TR/50x20	50x20	1 - 3	14,0	5
7371048	TR/50x25	50x25	1 - 3	14,5	5
7371049	TR/50x30	50x30	1 - 3	13,5	5
7371051	TR/50x30	50x30	3 - 5	14,5	5
7371053	TR/50x35	50x35	1 - 3,5	14,5	5
7371054	TR/50x40	50x40	1 - 3	12,5	5
7371057	TR/55x34	55x34	1,5 - 4	14,5	5
7371056	TR/55x40	55x40	1,5 - 4	14,5	5
7371058	TR/60x15	60x15	1 - 2	14,5	5
7371060	TR/60x20	60x20	1 - 3	14,5	5
7371061	TR/60x25	60x25	1 - 3	14,0	5
7371063	TR/60x30	60x30	1 - 3	15,0	5
7371064	TR/60x35	60x35	1,5 - 3,5	15,0	5
7371066	TR/60x40	60x40	1 - 3	14,0	5
7371067	TR/60x40	60x40	3 - 5	14,0	5
7371076	TR/60x45	60x45	1,5 - 4	15,0	5
7371068	TR/60x50	60x50	1,5 - 3,5	14,5	5
7371088	TR/65x35	65x35	1 - 3	15,0	5

Matière : Technopolymère noir.

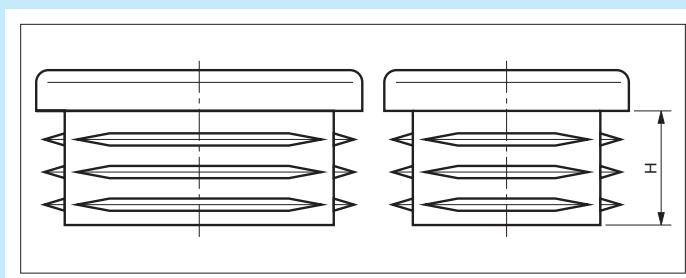

MESURES NON CONTRACTUELLES

TR

Embout à ailettes pour tube rectangulaire

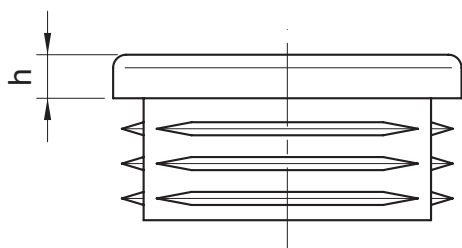

Code	Référence	dimension externe du tube	épaisseur du tube	H	h
7371070	TR/70x20	70x20	1 - 3,5	19,0	5
7371069	TR/70x25	70x25	1 - 2,5	18,0	5
7371071	TR/70x30	70x30	1 - 3	18,0	5
7371110	TR/70x35	70x35	1,5 - 3,5	15,0	5
7371073	TR/70x40	70x40	1 - 3	18,0	5
7371074	TR/70x40	70x40	2,5 - 4	15,0	5
7371111	TR/70x50	70x50	2 - 5	15,0	5
7371112	TR/75x25	75x25	1 - 3	15,0	5
7371113	TR/75x50	75x50	2 - 4	15,0	5
7371077	TR/80x20	80x20	1 - 3	18,0	5
7371114	TR/80x25	80x25	1 - 3	14,5	5
7371078	TR/80x30	80x30	1 - 2,5	14,5	5
7371080	TR/80x30	80x30	2,5 - 4	14,5	5
7371082	TR/80x40	80x40	1 - 3	14,5	5
7371084	TR/80x40	80x40	3,2 - 5	18	5
7371086	TR/80x50	80x50	1,5 - 4	24,0	5
7371087	TR/80x60	80x60	1,5 - 3,5	24	5
7371089	TR/80x60	80x60	3,5 - 5	24	5
7371115	TR/90x20	90x20	1 - 2,5	14,5	5
7371116	TR/90x40	90x40	2 - 4	15,0	5
7371117	TR/90x45	90x45	2 - 4	15,0	5
7371118	TR/90x50	90x50	2 - 4,5	22,0	6
7371119	TR/90x70	90x70	3 - 5,5	22,0	6
7371120	TR/100x20	100x20	1 - 3	15,0	5
7371121	TR/100x25	100x25	1 - 3	15,0	5
7371092	TR/100x30	100x30	1,5 - 3,5	15,0	5
7371090	TR/100x40	100x40	1,5 - 4	14,5	5
7371094	TR/100x50	100x50	2 - 3	24,0	6
7371096	TR/100x50	100x50	1,5 - 4,5	24,0	6
7371122	TR/100x60	100x60	1,5 - 4,5	24,0	6
7371123	TR/100x80	100x80	3 - 5,5	19,0	6,5
7371124	TR/110x60	110x60	3,5 - 5,5	24,0	6
7371125	TR/110x70	110x70	3 - 5	24,0	6
7371097	TR/120x30	120x30	1-2,5	16,5	5
7371098	TR/120x40	120x40	2	14,5	5
7371100	TR/120x40	120x40	3 - 5	21,5	6
7371126	TR/120x50	120x50	3 - 5,5	21,5	6
7371102	TR/120x60	120x60	1,5 - 5	24,5	5
7371105	TR/120x80	120x80	2 - 5	24,0	5
7371106	TR/120x80	120x80	5 - 8	25,0	7
7371127	TR/120x100	120x100	3,5 - 6	24,0	6
7371108	TR/140x80	140x80	2 - 4,5	24,5	5
7371128	TR/150x50	150x50	2 - 4	28,0	6
7371109	TR/150x100	150x100	1,5 - 5	27,0	6

Matière : Technopolymère noir.

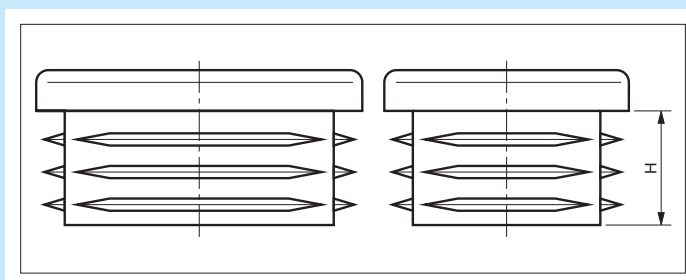

MESURES NON CONTRACTUELLES

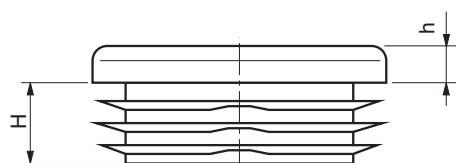
TT
**Embout à ailettes
 pour tube rond**

Code	Référence	Ø externe du tube	épaisseur du tube	H	h
7371301	TT/10	10	1 - 2	11,0	3,5
7371303	TT/12	12	1 - 2	11,0	3,5
7371305	TT/13	13	1 - 2	11,0	4
7371307	TT/14	14	1 - 2	11,5	5
7371309	TT/15	15	1 - 2	13,0	3
7371311	TT/16	16	1 - 2	11,0	5
7371313	TT/18	18	1 - 2	11,4	5
7371314	TT/19	19	1 - 2,5	11,4	5
7371315	TT/20	20	1 - 2,5	11,4	5
7371316	TT/21	21	1 - 2	11,5	5
7371317	TT/22	22	1 - 3	11,5	5
7371318	TT/23	23	1 - 2,5	11,5	5
7371324	TT/24	24	1 - 2,5	11,5	5
7371320	TT/25	25	1 - 3	11,5	5
7371326	TT/26	26	1 - 3	11,5	5
7371322	TT/27	27	1 - 3	11,5	5
7371323	TT/28	28	1 - 3	11,5	5
7371325	TT/30	30	1 - 2,5	11,6	5
7371327	TT/32	32	1 - 3	11,5	5
7371328	TT/34	34	1 - 3	11,5	5
7371331	TT/35	35	1 - 3	11,5	5
7371333	TT/36	36	1 - 3	11,5	5
7371334	TT/37	37	1 - 3	11,5	5
7371336	TT/38	38	1 - 3	11,5	5
7371338	TT/40	40	1 - 3	11,5	5
7371339	TT/42	42	1 - 3	11,5	5
7371340	TT/42	42	3 - 6	11,5	5
7371332	TT/43	43	2 - 2,5	11,5	5
7371342	TT/45	45	1 - 3	11,0	5
7371356	TT/46	46	1,5 - 3,5	11,5	5
7371344	TT/48	48	1,2 - 3,6	11,5	5
7371366	TT/48	48	2,5 - 5	11,5	5
7371345	TT/50	50	1 - 2,5	11,5	5
7371346	TT/52	52	1,5 - 3,5	14,5	5
7371348	TT/55	55	1 - 3	11,5	5
7371350	TT/60	60	1,5 - 3	18,5	5
7371351	TT/60/3	60	3 - 5	21,0	5
7371352	TT/65	65	1,5 - 3,5	21,0	5
7371353	TT/70	70	1 - 3,5	21,0	5
7371355	TT/76	76	1,6 - 4	21,5	6
7371358	TT/80	80	1,5 - 3	21,0	4
7371367	TT/85	85	1,5 - 4	21,0	6
7371368	TT/88	88	1,5 - 4	21,5	6
7371359	TT/90	90	1,5 - 5	19,9	6
7371360	TT/95	95	1,5 - 4	21,0	6
7371362	TT/100	100	2 - 4,5	28,5	6
7371361	TT/102	102	2 - 4	20,2	5
7371363	TT/105	105	2 - 4,5	29,0	6
7371369	TT/108	108	3 - 5	28,0	6
7371364	TT/110	110	2 - 4,5	28,5	6
7371370	TT/114	114	2,5 - 5,5	29,0	6
7371365	TT/120	120	2 - 4	28,5	6
7371371	TT/125	125	2 - 6	33,0	6
7371372	TT/130	130	2 - 6	33,0	6
7371373	TT/133	133	2 - 6	33,0	6
7371374	TT/140	140	2 - 6,5	34,0	6
7371375	TT/150	150	2 - 7	34,0	6
7371377	TT/160	160	2,5 - 7	34,0	6
7371378	TT/168	168	2 - 6,5	34,0	6
7371379	TT/194	194	2,9 - 8	34,0	6

Matière : Technopolymère noir.

MESURES NON CONTRACTUELLES

TRO

Embout à ailettes pour tube ovale

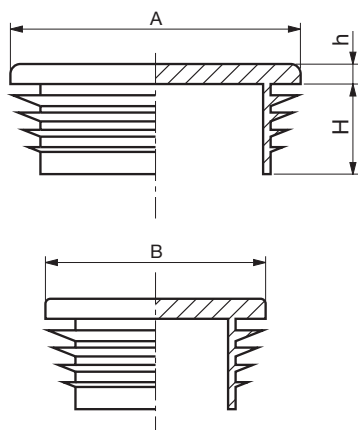

Code	Référence	dimension externe du tube AxB	épaisseur du tube	h	H
7372001	TRO/20x10	20x10	2	5	10
7372003	TRO/30x15	30x15	1 - 2,5	5	12
7372005	TRO/35x15	35x15	1,2 - 2,5	5	12
7372007	TRO/35x20	35x20	1,5 - 2	5	12
7372009	TRO/38x20	38x20	1 - 3	5	12
7372011	TRO/40x20	40x20	1 - 3	5	12
7372013	TRO/45x20	45x20	1 - 3	5	12
7372015	TRO/48x20	48x20	1,5 - 2	5	12
7372017	TRO/50x15	50x15	1 - 3	5	12
7372019	TRO/50x20	50x20	1 - 3	5	12
7372021	TRO/50x25	50x25	1 - 3	5	12
7372023	TRO/50x30	50x30	1 - 2,5	5	12
7372025	TRO/60x20	60x20	1 - 2	5	13
7372027	TRO/60x25	60x25	1 - 2	5	13
7372029	TRO/60x30	60x30	2	5	13

Matière : Technopolymère noir.