

6010-5

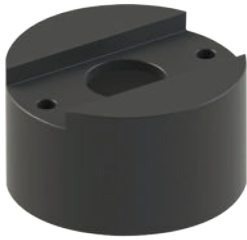

**Protezione Per Saldatura
(Per Stelo Pistone)**
Capot Protecteur de Tige Piston

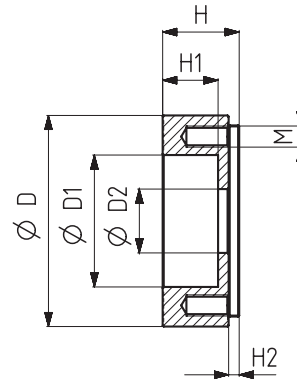
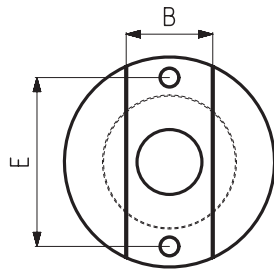

Opzioni di Montaggio
Options de Montage

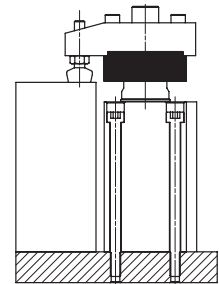

- 1)- Utilizzare solo con l'articolo serie 6011
- 1)- Ne peut être utilisé que pour les séries 6011

KOD	MODELLO NR	B	E	ØD	ØD1	ØD2	H	H1	H2	M	PESO (POIDS) (gr ±%)
6010-5-25	6011-25	16,4	32	40	25	14,1	14,5	9,5	2	M4	32
6010-5-32 - 40	6011-32-40	22,6	41,4	50	32	16,1	18	11	3	M6	59
6010-5-50	6011-50	25,8	46,5	60	39	20,1	33	24	5	M6	145

6010-6

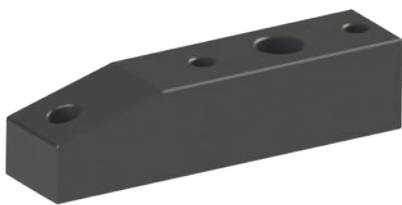

Staffa di Bloccaggio (Per Adattatore)
Squeezing Arm (For Protection Adapter)

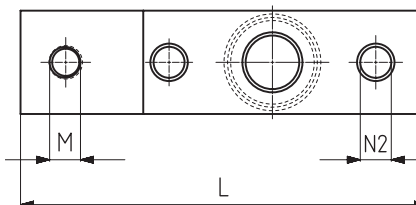
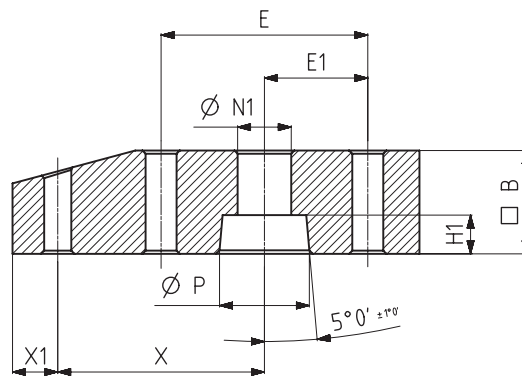

Opzioni di Montaggio
Options de Montage

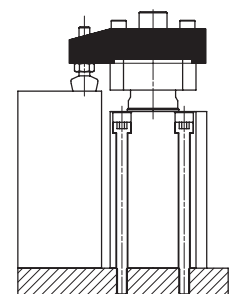

KOD	MODELLO NR	B	E	E1	H1	L	M	ØN1	ØN2	ØP	X	X1	PESO (POIDS) (gr ±%)
6010-6-25	6011-25	16	32	16	6,5	63	M6	8,5	4,5	14	32	7	102
6010-6-32 - 40	6011-32-40	22	41,4	20,7	9	82	M8	10,5	6,5	16	45	10	252
6010-6-50	6011-50	25	46,5	23,25	10	105	M10	12,5	6,5	20	65	10	420