

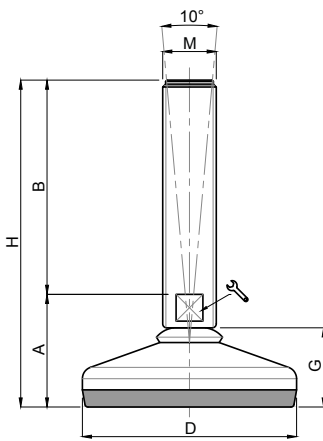





























Embases hygiéniques

Ø 100

Embase inox
Tige inox + Rondelle
Pied articulé oscillant fixable



CODE	DÉSIGNATION	DIMENSIONS							CHARGE MAXI
		A	B	D		M	G	H	
Standard									Newton
MA-25100/RB	M16x75	46	75	100	13 	M16	33	121	15 000
MA-25102/RB	M16x100	46	100	100	13 	M16	33	146	15 000
MA-25104/RB	M16x125	46	125	100	13 	M16	33	171	15 000
MA-25106/RB	M16x150	46	150	100	13 	M16	33	196	15 000
MA-25108/RB	M16x175	46	175	100	13 	M16	33	221	15 000
MA-25110/RB	M16x200	46	200	100	13 	M16	33	246	15 000
MA-25120/RB	M20x75	46	75	100	17 	M20	33	121	15 000
MA-25122/RB	M20x100	46	100	100	17 	M20	33	146	15 000
MA-25124/RB	M20x125	46	125	100	17 	M20	33	171	15 000
MA-25126/RB	M20x150	46	150	100	17 	M20	33	196	15 000
MA-25128/RB	M20x175	46	175	100	17 	M20	33	221	15 000
MA-25130/RB	M20x200	46	200	100	17 	M20	33	246	15 000
MA-25132/RB	M20x225	46	225	100	17 	M20	33	271	15 000
MA-25134/RB	M20x250	46	250	100	17 	M20	33	296	15 000
MA-25150/RB	M24x100	48	100	100	20 	M24	33	148	15 000
MA-25152/RB	M24x125	48	125	100	20 	M24	33	173	15 000
MA-25154/RB*	M24x150	48	150	100	20 	M24	33	198	15 000
MA-25156/RB	M24x175	48	175	100	20 	M24	33	223	15 000
MA-25158/RB*	M24x200	48	200	100	20 	M24	33	248	15 000
MA-25160/RB	M24x225	48	225	100	20 	M24	33	273	15 000
MA-25162/RB	M24x250	48	250	100	20 	M24	33	298	15 000
MA-25180/RB	M30x100	48	100	100	26 	M30	33	148	15 000
MA-25182/RB	M30x125	48	125	100	26 	M30	33	173	15 000
MA-25184/RB*	M30x150	48	150	100	26 	M30	33	198	15 000
MA-25186/RB	M30x175	48	175	100	26 	M30	33	223	15 000
MA-25188/RB*	M30x200	48	200	100	26 	M30	33	248	15 000
MA-25200/RB	M30x225	48	225	100	26 	M30	33	273	15 000
MA-25202/RB	M30x250	48	250	100	26 	M30	33	298	15 000

* Référence disponible au pas fin (code + P2)

matière

Embase en inox AISI 304 (316 sur demande).
Tige et rondelle en inox AISI 304 (316 sur demande) livrée sans écrou. Semelle en EPDM bleu.
Egalement disponible en versions : semelle caoutchouc vulcanisé ou EPDM gris.

note

Excellent rapport performance/coût.
Réalisation de dimensions et finitions spéciales de tiges filetées dès 100 pièces.
Semelle extrêmement résistante aux ripages ou déplacements de machines.
Excellente résistance aux produits alcalins. Particulièrement adapté aux contraintes de nettoyage des environnements agro-alimentaire, pharmaceutique et chimique.

