

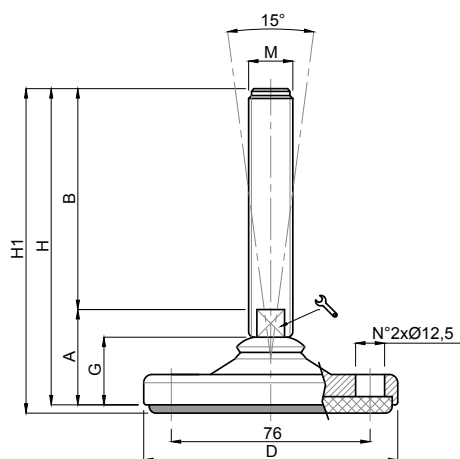





























## Embases inox massif

Ø 100

Embase inox  
Tige inox  
Pied articulé oscillant fixe

CODE		DÉSIGNATION	DIMENSIONS								CHARGE MAXI	
Standard	avec semelle		D	M	B		G	A	H	H1	Newton	
MA-20300/F	MA-20301/F	M16x50	100	M16	50	13		24	34	84	87	30 000
MA-20302/F	MA-20303/F	M16x75	100	M16	75	13		24	34	109	112	30 000
MA-20304/F	MA-20305/F	M16x100	100	M16	100	13		24	34	134	137	30 000
MA-20306/F	MA-20307/F	M16x125	100	M16	125	13		24	34	159	162	30 000
MA-20308/F	MA-20309/F	M16x150	100	M16	150	13		24	34	184	187	30 000
MA-20310/F	MA-20311/F	M16x175	100	M16	175	13		24	34	209	212	30 000
MA-20312/F	MA-20313/F	M16x200	100	M16	200	13		24	34	234	237	30 000
MA-20320/F	MA-20321/F	M20x75	100	M20	75	17		24	36	111	114	35 000
MA-20322/F	MA-20323/F	M20x100	100	M20	100	17		24	36	136	139	35 000
MA-20324/F	MA-20325/F	M20x125	100	M20	125	17		24	36	161	164	35 000
MA-20326/F	MA-20327/F	M20x150	100	M20	150	17		24	36	186	189	35 000
MA-20328/F	MA-20329/F	M20x175	100	M20	175	17		24	36	211	214	35 000
MA-20330/F	MA-20331/F	M20x200	100	M20	200	17		24	36	236	239	35 000
MA-20332/F	MA-20333/F	M20x225	100	M20	225	17		24	36	261	264	35 000
MA-20334/F	MA-20335/F	M20x250	100	M20	250	17		24	36	286	289	35 000
MA-20340/F	MA-20341/F	M24x100	100	M24	100	20		24	36	136	139	40 000
MA-20342/F	MA-20343/F	M24x125	100	M24	125	20		24	36	161	164	40 000
MA-20344/F	MA-20345/F	M24x150	100	M24	150	20		24	36	186	189	40 000
MA-20346/F	MA-20347/F	M24x175	100	M24	175	20		24	36	211	214	40 000
MA-20348/F	MA-20349/F	M24x200	100	M24	200	20		24	36	236	239	40 000
MA-20350/F	MA-20351/F	M24x225	100	M24	225	20		24	36	261	264	40 000
MA-20352/F	MA-20353/F	M24x250	100	M24	250	20		24	36	286	289	40 000
MA-20360/F	MA-20361/F	M30x100	100	M30	100	26		24	36	136	139	50 000
MA-20362/F	MA-20363/F	M30x125	100	M30	125	26		24	36	161	164	50 000
MA-20364/F	MA-20365/F	M30x150	100	M30	150	26		24	36	186	189	50 000
MA-20366/F	MA-20367/F	M30x175	100	M30	175	26		24	36	211	214	50 000
MA-20368/F	MA-20369/F	M30x200	100	M30	200	26		24	36	236	239	50 000
MA-20370/F	MA-20371/F	M30x225	100	M30	225	26		24	36	261	264	50 000
MA-20372/F	MA-20373/F	M30x250	100	M30	250	26		24	36	286	289	50 000

matière

Embase en inox AISI 304 (316 sur demande).  
Tige en inox AISI 304 (316 sur demande) livrée sans écrou.  
Semelle en caoutchouc NBR dureté 70° shore.

note

Réalisation de dimensions et finitions spéciales de tiges filetées dès 150 pièces.

